



SECURE CONNECTIONS. WORLD-WIDE.



THE STOCKO SUCCESS STORY

From the beginnings

STOCKO is a company with a tradition going back for more than one hundred years. The foundation stone was laid by Alfred Aders, Heinrich Pfeiffer, and Johann August Stock 1901 at Wuppertal under the name of Stock & Co. - as button manufacturers. Amongst other items, they produced hollow rivets, eyelets, and press fasteners that, during the Wilhelmian boom era, were in great demand and were even shipped to South America. When Stock & Co. developed the eyelet tag from a shoe eyelet with a solder tag added, the future direction of the company's activities was set: electrical technologies. Very soon there followed additional pressed, drawn, and seamed metal parts all of which could be manufactured with the same machines as the button parts up until now.

..... to the present

During the Weimar period that is during the twenties of the last century, the living habits of the people changed dramatically; modern electrical devices such as the radio, telephone, or even the electric shaver found entry into the households in large scale. The new direction of the company proved to be a particularly lucky move, 500 people were employed 1935; two years later there were already 1000. Now under the sole company name STOCKO. With the new factory at Malmedy in Belgium 1940, the company grew to a concern employing 1800 people. However, the war was not without consequences, and the number sank down to 300. There followed the years of the so-called "economic miracle", and STOCKO, too, gained by the new boom. Subsidiaries were founded like in England, France, Switzerland, and overseas. With the expertise, which STOCKO had gained in the manufacture of plastic parts, the product range was extended by film spools, tape cassettes, slide frames etc.. During these years, the expansions abroad continued steadily until far-reaching re-structuring measures took place during the nineties. In 1994, STOCKO divorced themselves from the division Fasteners. In 1998 a merger with the Bamberg Wieland Group took place and since then the company's name is STOCKO Contact GmbH. & Co. KG. Today STOCKO employ about 600 people at three locations: Sales and Marketing are at Wuppertal, production is distributed among the plants at Hellenthal (Germany) and Andlau/France.

1901

Founding of Messrs. Stock & Co. in Wuppertal-Elberfeld. The button factory has five employees. Hugo Henkels becomes a partner and later the sole proprietor.

1911

The subsidiary at Hellenthal/Eifel is set up. Stock & Co. employ already 110 workers at that time

1929

At the end of the twenties, start of the production of special parts for the electro-technical and radio industries

1950

Steady growth of the company

1960

Dr. Dirk Henkels, grandson of Hugo Henkels and son of Kurt Henkels (with the company since 1930) joins the firm

1998

Wieland Holding GmbH. take over Stocko Metallwarenfabriken, Henkels und Sohn GmbH & Co..
New name : STOCKO Contact GmbH & Co. KG.

2001

STOCKO celebrate their centenary at Wuppertal.





STOCKO has met the great ruptures and frequent changes of the industry in masterly fashion.
 Today the company is well prepared to continue with the 100 year old tradition also in the future.

2007

STOCKO France celebrate their 50th anniversary at Andlau.

2009

The Malmedy factory, one of four production facilities to date, will be closed in spring 2009 and the production will be relocated to Hellenthal.

2011

STOCKO Hellenthal celebrate their 100th anniversary.

2012/2013

A high volume of investment in all factories and divisions. Significant improvement in infrastructure, machinery and large parts of production.

2014

Production area extension by 1,000m² in Hellenthal
 Construction work in the order of 3,000m² is being completed in Andlau.

2016/2017

In order to ensure the continued growth of STOCKO France, land in the order of 20,000 m² was acquired in 2016 and a property on it with a building area of 3,500 m² has been core redeveloped.

2017

As part of its growth strategy, STOCKO is once again investing in the Hellenthal location and is expanding its production and administration areas by around 3,000 m² with the construction of a new hall.



The Company.....	4 - 23
<hr/>	
Connector Systems	
Pitch 2,5 mm.....	24 - 26
Pitch 2,54 mm.....	27
Pitch 3,5 mm.....	28
Pitch 4,2 mm.....	29
Pitch 5 mm.....	30 - 35
Pitch 5,08 / 7,62 mm.....	36 - 37
Pitch 6,35 mm.....	38
Pitch 6,5 mm.....	39
Pitch 8 mm.....	40
Circular Connector.....	41
Pin Strips.....	42
<hr/>	
Insulation housings.....	43
<hr/>	
Crimp contacts, loose and in bandolier form.....	44 - 45
<hr/>	
Automotive.....	46 - 50
<hr/>	
Customers' special products.....	51
<hr/>	
Solderless terminals.....	52
<hr/>	
Terminating systems.....	53



ASSURED QUALITY

CERTIFIED INTEGRATED MANAGEMENT SYSTEMS

- Certified according to
ISO 9001
ISO 14001
IATF 16949
- Certified according to
ISO 50001
STOCKO CONTACT Germany

STOCKO CONTACT Germany, France



COMPANY PROFILE

OUR MARKETS

- Domestic appliances industry
- Industry
- Automotive
- Heating industry
- Distribution

OUR PRODUCTS

- Multi-way connector systems with terminations for insulation displacement crimping or soldering
- Solderless terminals
- Crimp contacts
- Customers' special products
- Terminating systems for all STOCKO products: Hand tools, semi- and fully automated machines

FACTORIES

- Wuppertal / Germany
- Hellenthal / Germany
- Andlau / France
- Sokolov / Czech Republic
- Shanghai / China

FOUNDED

- 1901 in Wuppertal

EMPLOYEES WORLD-WIDE

- 700

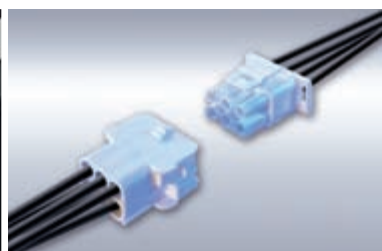

DEVELOPMENT

Design and Development

STOCKO products are renowned and held in high estimation. They represent solid solutions and a multitude of applications as connectors and terminals. The growing functionality and complexity in this sector, however, limits the usage of volume-produced standard components; more and more customers demand individual applications or new designs. Such processes need know-how, ideas, and adjustment to technical and economical philosophies in a sensible manner. Together with our customers, we are concentrating our energy on the expected performance of the new product and, step by step, work out the details – the material, the surface finish, the physical properties and finally the design. For design and development, we have the most modern, computer aided systems at our disposal. With the stereolithography method for example, we are in a position to check the precision of future products with the aid of prototypes, or manufacture prototype samples for testing purposes. Before reaching marketing stages, all STOCKO products are subjected to rigorous test procedures in our laboratories to check the mechanical and electrical properties as well as the influence they may have on the environment.

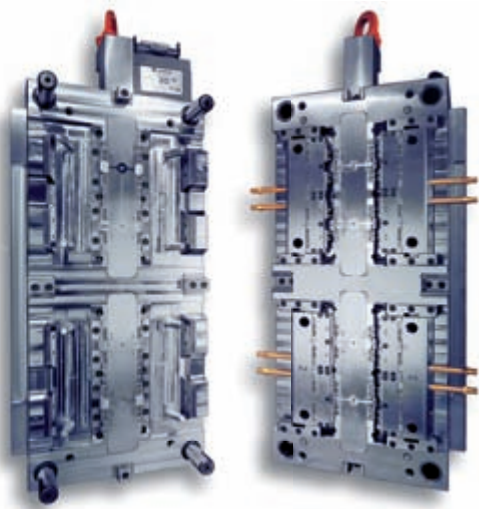

Toolmaking

Absolutely essential and a decisive component in our successful connector technology, is our toolmaking capability and that takes place inhouse at STOCKO. The production tools with which amongst other things the negative forms of housings are produced are of paramount importance that quality is assured, and our design teams for electro-technical components have to adhere to strict guidelines with regard to the mechanical design of such components. All press and moulding tools are built by STOCKO according to the latest state of the art. They are central in a value producing chain that ultimately is to the benefit of our customers.





Our laboratories test all components of their suitability for volume production.

The quality and equipment of our laboratories are of such high level that the VDE approvals and certification institute uses them to carry out their own independent tests. These include VDE and even the stringent CSA and UL tests for the international markets.



Milling machine with automation

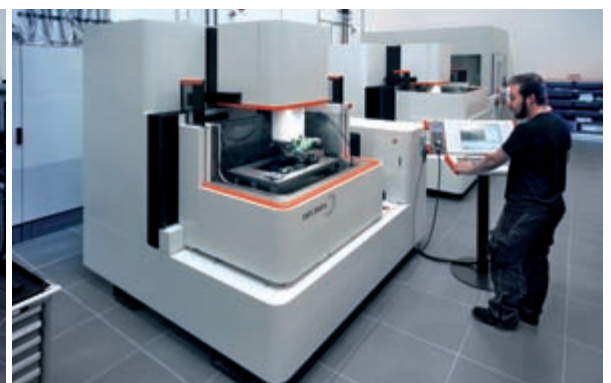

Wire cutting machine



» HIGHLY FLEXIBLE AUTOMATION «

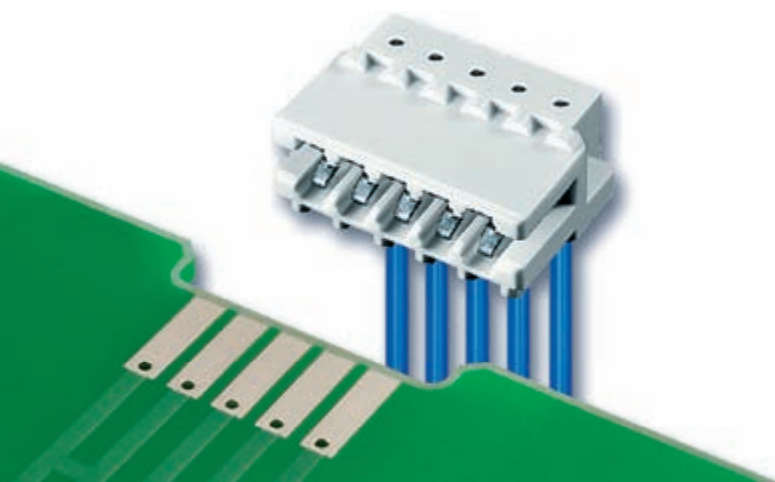



MANUFACTURING TECHNOLOGY

Production of Plastic Mouldings

Production at STOCKO is concentrated in manufacturing centres to secure the highest quality even with growing output rates. Thus the whole production of plastic parts is at our Hellenthal plant.

With this location specializing on this sector, they can fully concentrate on to the highly technical requirements of those parts such as the production of a maximum number of pin count with a minimum contact spacing and the closest possible tolerances, processing special flame retarding plastic materials, usage of a wide range of materials, and a high machine output rate. For this, we rely on the most modern machines available. We compliment our fully automated moulding presses with intelligent ancillary devices and tooling from our own in-house production.

With regard to production techniques and the development of new possibilities for plastic materials, we are constantly aiming for the best possible solutions. This is hard cast quality.



MANUFACTURING TECHNOLOGY

Stamping

Stamping technology at STOCKO stands for the highest level of economy and quality. At our production centres in Hellenthal and Andlau we produce the precision stamped parts for our various product groups both in bands and loose. For this we have the latest high-performance stamping machines with speeds of between 100 and 1400 strokes per minute and a compression force range of up to 160 tonnes. All the presses are equipped with the latest peripherals.

Rationalised production stages, a high level of automation and well designed integrated process monitoring systems guarantee year-on-year increased productivity that we ensure with the latest electronic quality control. Here we produce our stamped, drawn and formed parts with downstream composite tools made in-house and precisely tailored to the process architecture. This creates further cost benefits that we can pass on to our customers.





» HIGHLY FLEXIBLE AUTOMATION «

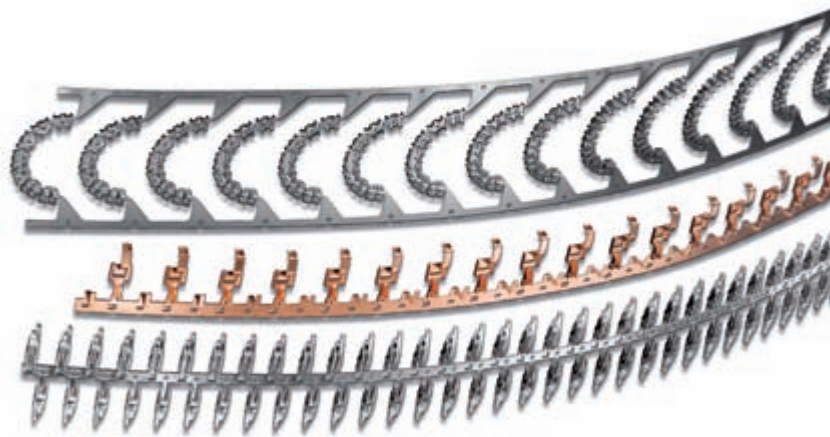

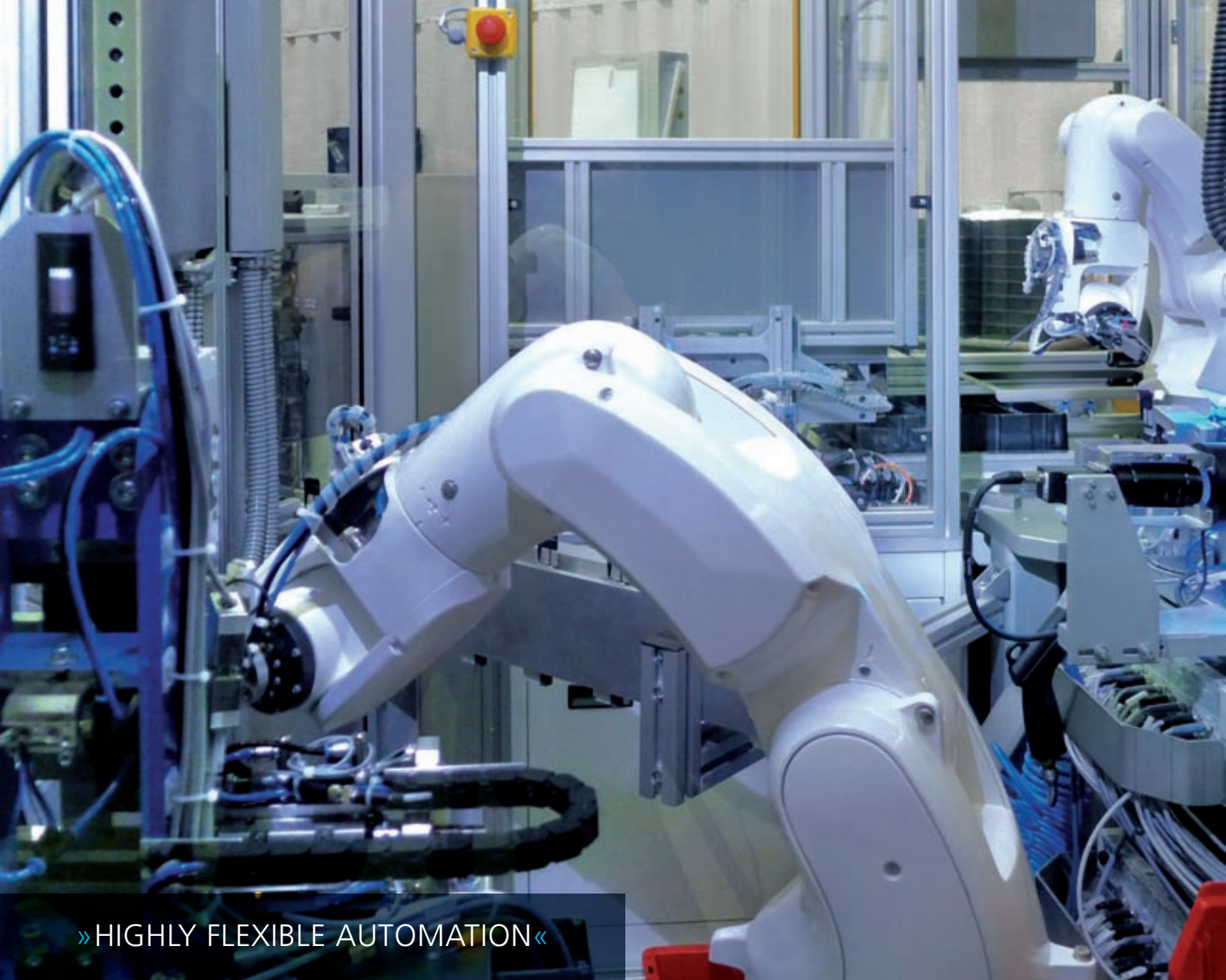

» HIGHLY FLEXIBLE AUTOMATION «

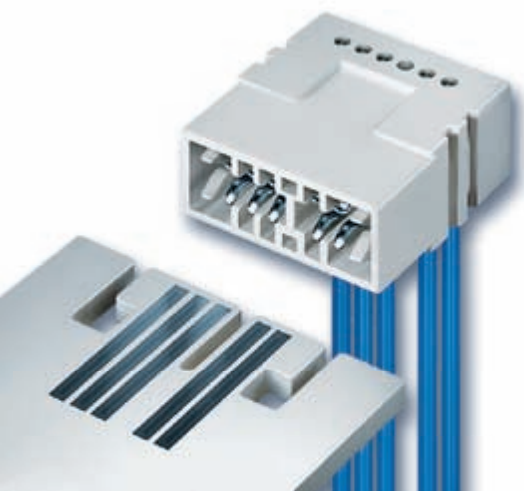

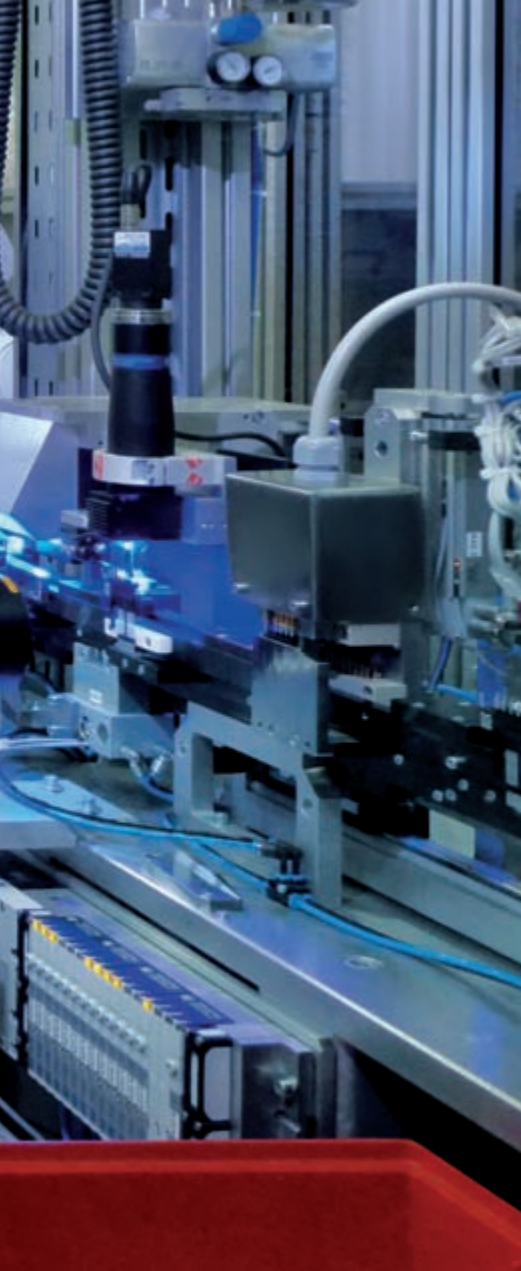

MANUFACTURING TECHNOLOGY

Assembly

Our connector systems are assembled by STOCKO in Hellenthal (Germany) and Sokolov (Czech Republic) using fully automated processes.

Here, too, we apply the STOCKO philosophy of developing and producing most of the machinery, tooling and auxiliary devices in-house.

The result is a highly flexible degree of automation leading to our high quality standards, which are assured with control systems that have also been developed in-house.



MACHINE BUILDING

We give high priority to our STOCKO terminating systems, because the quality and reliability of an electrical connection is largely determined by the high levels of the terminating technology. That is why we allocate considerable financial resources to the development and production of such systems. In addition to quality, innovation and economies play important parts. Our aim is to improve the productivity of our customers by integrating our terminating machines smoothly into their production processes. Thus once more, STOCKO solutions act as catalysts and enable profitable competition. And to make sure everything runs smoothly, training is given to your staff for the various production processes, and our team of service engineers is always at your disposal with help and advice to ensure productivity all along the line.

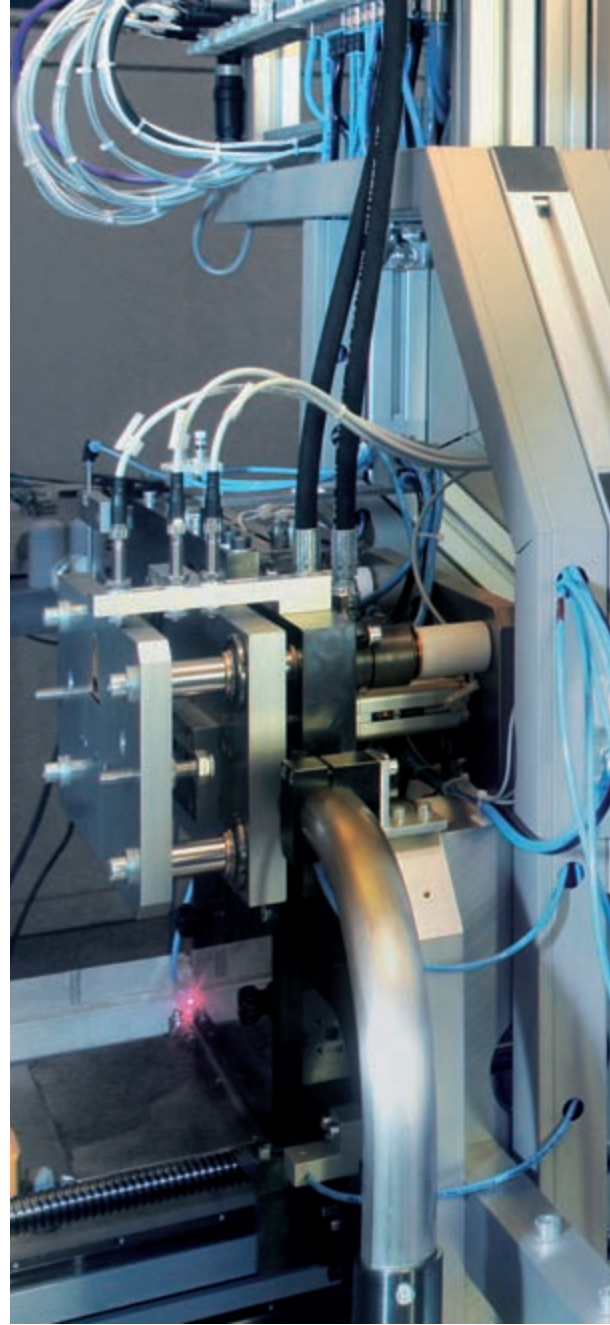



» PRODUCTIVITY ALL THE WAY «



STOCKO Terminating Technology - for every type of application, from simple hand tools, to semi-automated machines, and ultimately to fully automated modular machines with "Just in Time" functions, computer controlled, automated quality control functions, modem connections for outside diagnostic centres and the option to programme sequences of cable forms.



Environmental protection

We take it as our social responsibility to integrate environmental protection in our manufacturing processes. For this reason, the plating shop at our manufacturing centre at Andlau was only recently modernized and converted taking account of the latest environmental and ecological developments. In an elaborate process, all effluents are returned to nature, purified and completely free of harmful substances.

STOCKO QUALITY

Quality is our highest premise

For it is the best argument for customers' satisfaction and a solid position in a hard fought market. This quality approach at STOCKO does not simply begin at the manufacturing stage.

From the first initial contact, we wish our customers to know they are in safe hands and can rely on this also during the planning and development stages: with an application oriented design, the uncompromising selection of the most suitable materials, and strict observation of the customers' requirements profile. International standards can only act as guidelines for us. We exceed their demands by setting our own additional standards: with our own designed testing programs, in-house laboratories, a continued striving for optimal organisational processes during all phases and a close exchange of experiences and know-how with our customers and users.

In addition to this, our quality offensive goes even further in that our environmental responsibilities are firmly imbedded in our manufacturing processes. Right from the development stage of our products, we aim for the conscientious use of our raw material resources. All our plastics and metal materials are recyclable and our state-of-the-art production processes completely eliminate the use of chlorinated hydrocarbons and chlorofluorocarbons. Moreover and to avoid waste, STOCKO are using re-usable packaging systems such as blister packs, reels, and magazines.

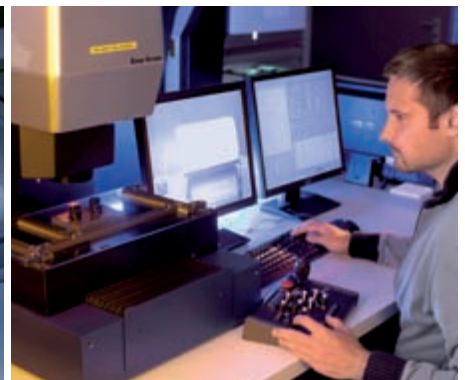

STOCKO QUALITY

DIN EN ISO 9001 and IATF 16949

Having been awarded certification to ISO 9001, we have received approval that a quality management system is in operation throughout all areas of activity that assures a uniform high level of quality. Likewise, this is also the basis for specification IATF16949. This certification is a prerequisite to qualify as supplier to the automotive industry. It acknowledges that the company has set up special procedures in all areas of activity and, therefore, complies with customers' specific demands in the automotive sector. Thus and in the long-term, STOCKO increase the efficiency and safety for their customers and themselves.

DIN EN ISO 14001

In recent years we have with great commitment incorporated numerous improvement processes into our company environmental policy and constantly expanded them. Since 2011 our factory in Andlau has met the strict requirements of environmental management standard ISO 14001 and since 2012 our factory in Hellenthal has done so too. By doing so, we commit ourselves to a far greater extent than normal to the voluntary reduction of environmental risks such as waste, waste water and emissions. We are constantly planning, implementing and monitoring our goals in this regard. For us they are a major factor in our value system.

DIN EN ISO 50001

It has long been one of our corporate goals to keep increasing the energy efficiency in our plants while at the same time reducing energy consumption as well as CO₂ emissions.

For sustainable control and optimisation, STOCKO has developed an intelligent energy management system with which we can precisely detect any energy losses and initiate countermeasures at an early stage. ISO 50001 certification for this is for us the worthwhile supplement to ISO 14001. Whereas there energy is only a partial aspect, the focus in ISO 50001 lies on the energy efficiency of a company. With our energy management system we are, in the best-case scenario, even going beyond the strict requirements of this ISO because we can among other things increase our efficiency even without increasing our energy consumption.



Environmental Protection

Preserving our environment and natural resources for future generations is an integral part of the company policy and is enshrined in the management principles of STOCKO CONTACT.



 For the sake of the environment.



»PRECISELY ADJUSTED FOR YOU«



SERVICE

Service and close proximity with our customers has always been a top priority and form an integral part of the STOCKO philosophy.

Of course, to discuss with our customers their specific requirements and to meet their expectations in the best possible way is part of our flexibility. We wish to offer our customers superior performance characteristics and to support them in their business activities by anticipating future requirements.

Our customers shall be able to rely upon us so that they become true partners eventually. Partners, who we can assist with our know-how and comprehensive knowledge of the markets. Particularly our sales engineers and our service engineers carry this part of our philosophy outside. Moreover, an extensive network of subsidiaries, sales offices, and agencies around the world assist in bringing this principle close to our customers wherever they are. This network will be expanded still further during the next few years so that our customers can benefit from close on-site support even more efficiently.

And should one of our customers ever ask if we are the right partners then something must have gone wrong from our part.





» SAFELY CONNECTED TO PROGRESS «





MARKETS & PRODUCTS

Our Markets

Developments in the electro-technical market are short-lived and permanently exposed to innovative pressures; again and again the limits are newly defined. How gratifying, there is a safe constancy on which one can rely. STOCKO offer such constancy. Our name stands synonymous for connector systems in crimp and ID form, crimp contacts, solderless terminals, and special parts. Millions of all these elements perform their tasks unnoticed and reliably day in, day out. STOCKO components ensure secure and advanced connections and progress in a wide range of industries and areas of application. A range as wide as household appliances, the heating industry, automotives, industrial and entertainment electronics, control equipment and machine building, as well as the sectors multi-media and telecommunication. Maintaining the well-proven STOCKO quality, we are continuously upgrading the performance of our products to changing market conditions enabling us to set standards for customers of the highest levels of expectation.

Our Products

Connector systems in insulation displacement, crimp or solder form
Crimp contacts
Solderless terminals
Customers' special products
Terminating systems for all STOCKO products: hand tools, semi-automated and fully automated machines.

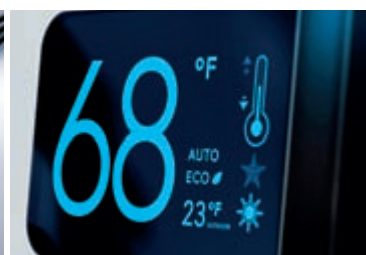
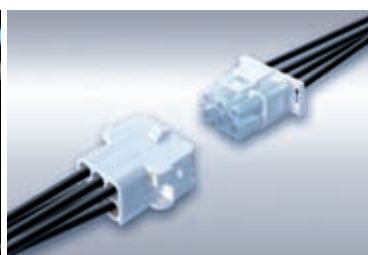

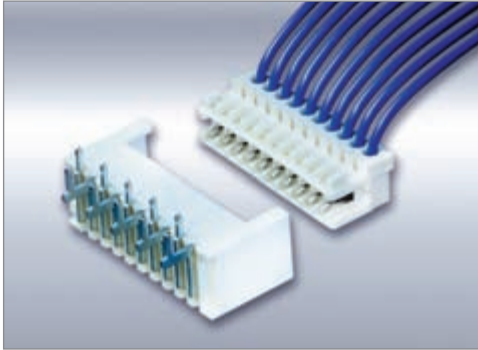

DESCRIPTION OF SYSTEM

IDC housings

- Direct and indirect connectors with IDC termination in accordance with the RAST 2.5 standard specification for domestic appliances
- Trimming polarizing pegs to individual requirements produces a large number of clearly defined connector combinations
- With direct edge versions, polarizing and locking feature for PCB

Pin connectors

- In vertical and horizontal versions facilitate 90° and 180° cable angles
- SMT version for vertical PC board assembly

Pin connector panel mount

- Pin connector with IDC termination for entry through back panel
- Lockable in metal thickness 0.8 ± 0.1 mm

TECHNICAL DATA

Mechanical	Pitch	2.5 mm
	Positions	2 - 20
	Termination	IDC
	Wire size	0.12-0.14mm ² / 0.22 - 0.35 mm ²
	Insulation Ø	max. 1.6 mm
	Hardness of insulation	Shore A 90° ± 5
	Type of wire	solid, stranded
	Temperature range	-40 °C ...+ 120 °C
	Board thickness	1.55 ± 0.19 mm
	Electrical	Rated current
Rated voltage		Pitch 2.5 mm: 32 V Pitch 5 mm: 250 V
Dielectric strength		Fully assembled 2.5 mm: 1.4 kV Partially assembled 5 mm: 2.8 kV
Insulation resistance		> 10 ⁹ Ω
Contact resistance		< 10 m Ω
Air gap and creeping distances		Pitch 2.5 mm: > 1 mm Pitch 5 mm: > 3 mm
Creeping strength		CTI ≥ 400
Approved IDC connector		UL / ULC E96569 DIN EN 61984 (IEC 61984) according to - LV 214: 2010-03 - USCAR-2
Approved Pin connectors		UL/ ULC E96569 DIN EN 61984 (IEC 61984)
Materials		Contact
	Contact finishing	Socket: Sn, NiAu / Pin: Sn
	Housing	PA, glow wire resistant, GWT 750 °C acc. to IEC 60335-1
	SMT pin connector	PA, glow wire resistant, GWT 750 °C acc. to IEC 60335-1
	Colour of housing Polarizing	natural, SMT pin connector black to RAST 2.5

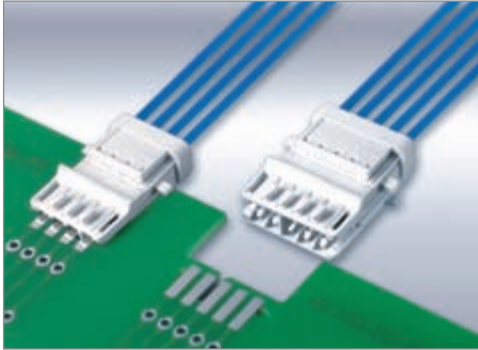

DESCRIPTION OF SYSTEM

Crimp housings

- Direct and indirect connectors with crimp termination
- Codings in accordance with the RAST 2.5 standard specification for domestic appliances
- Closed cable entries ensure long air and creepage distances
- Trimming polarizing pegs to individual requirements produces a large number of clearly defined connector combinations
- With direct edge versions, polarizing and locking feature for PCB
- Primary and secondary lock

Pin connectors

- In vertical and horizontal versions facilitate 90° and 180° cable angles
- SMT version for vertical PC board assembly

Pin connector panel mount

- Compatible with pin connector of ECO-TRONIC with IDC termination
- Lockable in metal thickness 0.8 ± 0.1 mm

TECHNICAL DATA

Mechanical	Pitch	2.5 mm
	Positions	2 – 12 (up to 20 on request)
	Termination	crimp technology
	Wire size	0.22 and 0.35 mm ²
	Insulation Ø	max. 1.4 mm
	Hardness of insulation	Shore A 90° ± 5
	Type of wire	stranded
	Temperature range	-40 °C ...+ 120 °C (Sn)
	Board thickness	1.55 ± 0.19 mm
	Electrical	Rated current
Rated voltage		Pitch 2.5 mm: 32 V Pitch 5 mm: 250 V
Dielectrical strength		Fully assembled 2.5 mm: 1.4 kV Partially assembled 5 mm: 2.8 kV
Insulation resistance		> 10 ⁹ Ω
Contact resistance		< 10 m Ω
Air gap and creeping distances		Pitch 2.5 mm: > 1 mm Pitch 5 mm: > 3 mm
Creeping strength		CTI ≥ 400
Approved Crimp connector		DIN EN 61984 (IEC 61984) according to - VW 60330 - LV 214: 2010-03 - USCAR 2
Approved Pin connectors		UL / ULC E96569 DIN EN 61984 (IEC 61984)
Materials		Contact Socket:
	Contact finishing	Sn, NiAu
	Housing	PA, glow wire resistant, GWT 750°C acc. to IEC 60335-1
	Colour of housing	natural
	Polarizing	to RAST 2.5



DESCRIPTION OF SYSTEM

Socket connectors

- Crimp version for indirect connections, wire range 0.12 - 0.5 mm²
- IDC version for direct and indirect connections, wire range 0.14 - 0.25 mm²
- Suitable for terminating ribbon cables and discrete wires

Pin connectors

- With or without snap-in locking device, for vertical or horizontal connections
- The tandem pin connectors can be used as flying lead connection

TECHNICAL DATA

Mechanical	Pitch	2.5 mm
	Positions	up to 20
	Termination	IDC, crimp, soldering
	Temperature range	-40 °C + 115 °C
Electrical	Rated current	5 A / 30 °C 2.5 A / 70 °C
	Insulation resistance	>10 ⁹ Ω
	Contact resistance	<10 m Ω
	Test voltage	≥ 1 kV
	Rated voltage	32 V
	Approved by	UL E96569
Materials	Housing	PC, glow wire resistant, GWT 750 °C acc. to IEC 60335-1
	Contact	CuSn
	Finishing	Sn



DESCRIPTION OF SYSTEM

- Suitable for the connection to HVAC periphery devices, e. g. stepping/servo motors or linear actuators
- Housing variants
 - In-line 3-positions or
 - dual-line 6-positions
- Three different coding variants
- Cable exit 180°

SMD Socket Connector

- 4 to 80 poles socket connector doublerow
- Board to board connection (bottom entry) with 0.64 x 0.64 mm pins
- Surface Mount Technology
- Contact area flash gold, soldering area tin plated

TECHNICAL DATA

		Housing	SMD Socket connector
Mechanical	Positions	3 / 6	4-80
	Pitch	2.54 mm	2.54 mm
	Termination	Crimp	SMD soldering
	Wire size	0.14 - 0.34 mm ² AWG 26-22	
	Temperature range	- 20 °C ... + 110 °C	- 40 °C ... + 105 °C
Electrical	Rated current	max. 3 A at T _{amb} 80 °C	max. 1 A at T _{amb} 95 °C (max. 3 A at T _{amb} 47 °C)
	Rated voltage	250 V	250 V
	Dielectrical strength	≥ 2.5 kV	≥ 1.39 kV
	Insulation resistance	> 10 ⁹ Ω	> 10 ⁹ Ω
	Contact resistance	< 10 m Ω	< 40 m Ω
	Air gap	1.5 mm	1.5 mm
	Creeping distances	1.8 mm	≥ 1.25 mm
	Creeping strength	CTI ≥ 425	CTI ≥ 600
Materials	Housing	PA, glow wire resistant, GWT 750 °C acc. to IEC 60335-1	PA, glow wire resistant, GWT 750 °C acc. to IEC 60335-1
	Colour of housing	various colors	black
	Associated contact	RVB 8231.001 Z 0.64-0.35	
	Contact	CuSn	CuSn
	Contact finishing	Sn	Contact area: gold flash, Soldering area: Sn

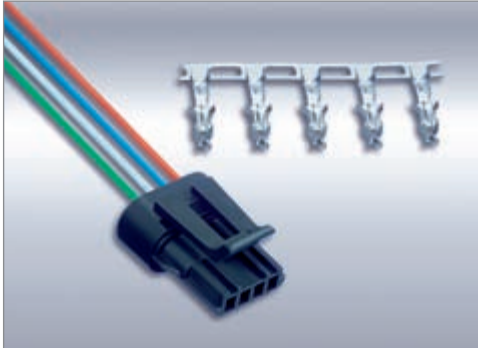

DESCRIPTION OF SYSTEM

- Suitable for the connection to HVAC periphery devices, e. g. stepping/servo motors or linear actuators
- Pitch 3.5 mm
- Pluggable connector with external locking feature
- Crimped wires are from the rear insertable
- Cable exit 180°
- Remarks with or without seal
- With seal IP 44
- Clear positioning

TECHNICAL DATA

Mechanical	Positions	4
	Pitch	3.5 mm
	Termination	Crimp
	Temperature range	-40 °C ... +120 °C
	Wire size	0.12 - 0.5 mm ²
Electrical	Rated current	max. 5 A
	Rated voltage	250 V
	Insulation resistance	> 10 ⁹ Ω
	Contact resistance	< 10 m Ω
Materials	Housing	PA, glow wire resistant, GWT 750 °C acc. to IEC 60335-1
	Colour of housing	black
	Associated contact	RFB 7808 V 0.6-0.5
	Contact	CuSn
	Contact finishing	Sn

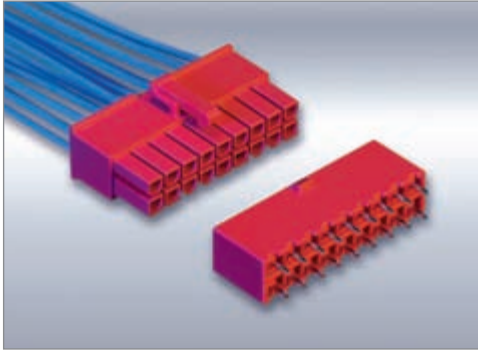

DESCRIPTION OF SYSTEM

- Universal connector system for internal equipment wiring
- Applicable as flying lead coupling, for panel mounting or for printed circuit board contacting
- Available in a range of versions and materials
- Crimp contacts are touch-protected into the housing located
- Cable exit 180°

TECHNICAL DATA

Mechanical	Positions	Single-row	2 - 6
		Dual-row	2 - 24
	Pitch		4.20 mm
	Termination	Connector, Counter part	Crimp
		Headers	Solder
	Wire size		0.22 - 0.48 mm ² / AWG 24-22 0.50 - 1.00 mm ² / AWG 20-18
	Degree of pollution		II
	Temperature range		-40 °C ... +110 °C
Electrical	Rated current		7 A
	Rated voltage		250 V
	Insulation resistance		> 10 ⁹ Ω
	Contact resistance		< 10 mΩ
	Air gap and creeping distances		≥ 3 mm
	Creeping strength		CTI ≥ 325*
	Surge category		II
	Insulation group		III a*
	Dielectric strength		3 kV
	Approved by		UL / ULC E96569
Materials	Housing		PA PA, glow wire resistant, GWT 750 °C acc. to IEC 60335-1
	Colour of housing		natural, other colours on request
	Contact		CuZn
	Contact finishing		Sn

* Depending on material

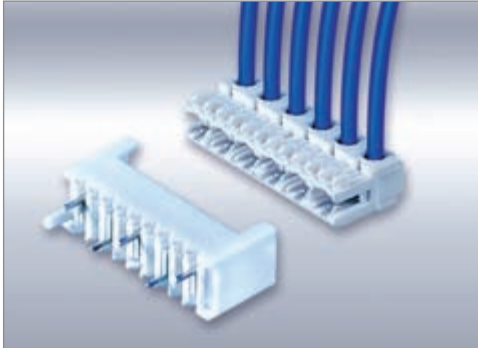

DESCRIPTION OF SYSTEM

IDC housings

- Direct and indirect connectors with IDC termination in according to the RAST 2.5 standard specification for domestic appliances
- Trimming polarizing pegs to individual requirements produces a large number of clearly defined connector combinations
- With direct edge versions, polarizing and locking feature for PCB

Pin connectors

- Versions for vertical or horizontal PC board assembly

TECHNICAL DATA

Mechanical	Pitch	5 mm
	Positions	2 - 10
	Termination	IDC
	Wire size	0.35 - 0.75 mm ²
	Insulation Ø	max. 2.4 mm
	Hardness of insulation	Shore A 90° ± 5
	Type of wire	stranded
	Temperature range	-40 °C ...+ 120 °C
	Board thickness	1.55 ± 0.19 mm
	Electrical	Rated current
Rated voltage		250 V
Dielectric strength		2.8 kV
Insulation resistance		> 10 ⁹ Ω
Contact resistance		< 10 m Ω
Air gap and creeping distances		> 3.2 mm
Creeping strength		CTI ≥ 400
Approved by		DIN EN 61984 (IEC 61984) UL / ULC E96569
Materials		Contact
	Contact finishing	Socket: Sn Pin: Sn
	Housing	PA, glow wire resistant, GWT 750 °C acc. to IEC 60335-1
	Colour of housing	natural
	Polarizing	to RAST 2.5

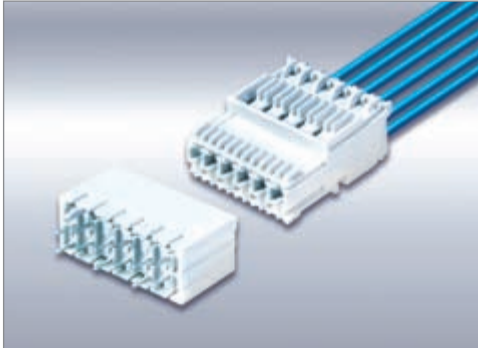

DESCRIPTION OF SYSTEM

IDC housings

- Direct and indirect connector with IDC termination in accordance with the RAST 5 standard specifications for domestic appliances, with locking features inside or outside
- Direct connector with central polarizing and polarizing pegs at sides, locking features for PCB
- Cable exit 90° and 180° according to RAST 5

Tab connectors

- Versions for vertical or horizontal PC board assembly see series ECO-FLEX M

TECHNICAL DATA

Mechanical	Pitch		5 mm
	Positions	Direct connector	2 - 12
		Indirect connector	1 - 12
	Locking features	Direct connector	PCB
		Indirect connector	inside and outside
	Termination		IDC
	Wire size	Direct connector	0.5 - 0.75 mm ²
		Indirect connector	0.35 - 1.5 mm ²
	Insulation diameter		3.0 mm
	Cable exit 180°		max. ≤ 2.4 mm
	Type of wire		stranded
	Temperature range		- 40 °C ...+ 110 °C
	Electrical	Rated current	Direct connector
Indirect connector			16 A
Rated voltage			250 V
Dielectrical strength			≥ 3.0 kV
Insulation resistance			≥ 10 ⁹ Ω
Contact resistance			≤ 5 m Ω
Air gap			≥ 3 mm
Creeping distance			≥ 3.6 mm
Creeping strength			CTI ≥ 400
Approved by			DIN EN 61984 (IEC 61984) UL / ULC E96569
Materials	Contact		Socket: CuSn
	Contact finishing		Socket: Sn
	Housing		PA, glow wire resistant, GWT 750 °C acc. to IEC 60335-1
	Colour of housing		natural

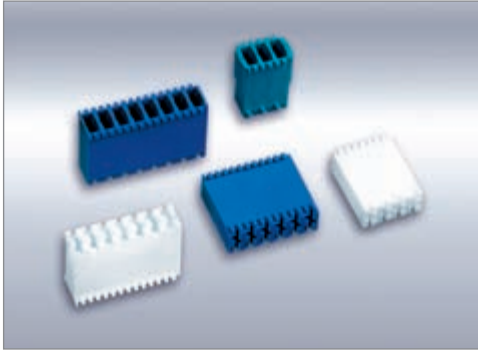

EH 688



DESCRIPTION OF SYSTEM

Housings

- Housing with crimp connection
- Dimensions of housing in accordance with RAST 5 standard specification for domestic appliance
- Different polarizing features
- Indirect connector with inside locking device
- Cable exit 90° / 180°



EH 699



TECHNICAL DATA

Mechanical	Pitch		5 mm	
	Positions	EH 699	2 – 8	
		EH 688	1 – 8	
		EH 788	2 – 6	
	Locking features		inside	
			6,3 FSH	
	Termination		Crimp technology	
Wire size		0.5 – 1.5 mm ²		
Insulation-Ø		max. 3.3 mm		
Temperature range	EH 688 / EH 699	-40 °C ... +120 °C		
	EH 788	-40 °C ... +135 / 140 °C		
Electrical	Rated current		16 A	
	Rated voltage		250 / 400 V	
	Dielectrical strength		≥ 3.0 kV	
	Air gap		≥ 3 mm	
	Creeping distance		≥ 3 mm	
	Approved by	EH 688 / EH 699	DIN EN 61984 (IEC 61984)	
		EH 688	UL / ULC E96569	
EH 699		UL E306640		
EH 788		UL E306845		
Materials	Housing		PA, glow wire resistant, GWT 750°C acc. to IEC 60335-1	
	Colour of housing		natural other colours on request	



DESCRIPTION OF SYSTEM

Tab connector

- For flying lead or panel mounting
- Dimensions of housing in accordance with RAST 5 standard specification for domestic appliance
- Mating connector for series ECO-DOMO NF and ECO-DOMO Crimp
- The connection is made on 6.3 x 0.8 mm tab
- Different codings

TECHNICAL DATA

Mechanical	Positions	2 - 10
	Pitch	5 mm
	Temperature range	-40 °C ... +130 °C
	Panel thickness	0.8 - 1.0 mm
Electrical	Current rating	max. 16 A
	Nom. voltage	max. 400 V
	Approved by	DIN EN 61984 (IEC 61984)
Materials	Housing	PA, glow wire resistant, GWT 750 °C acc. to IEC 60335-1
	Contactx	CuZn, Sn



DESCRIPTION OF SYSTEM

- Tab connector for IDC termination as flying lead coupling or for panel mounting application
- Versions with / without back panel clips
- Cable exits 90°, 180° (optional 270°)
- Single and / or twin terminations depending on wire size
- Codings in accordance with the RAST 5 standard specifications for domestic appliance
- Label optional

TECHNICAL DATA

Mechanical	Pitch	5 mm
	Positions	2 - 10
	Termination	IDC
	Wire size	0.5 - 0.75 mm ² / 0.5 + 0.5 mm ²
	Insulation diameter	2.3 mm
	Type of wire	stranded wire
	Temperature range	- 40 °C ...+ 110 °C
Electrical	Rated current	10 A
	Rated voltage	250 V
	Dielectrical strength	2,5 kV
	Creeping strength	CTI ≥ 400
	Air gap and creeping distance	≥ 4 mm
	Insulation resistance	> 10 ⁹ Ω
	Contact resistance	< 10 m Ω
Materials	Approved by	DIN EN 61984 (IEC 61984)
	Contact	tabs 6.3 x 0.8 mm
	Contact material	CuSn
	Contact finishing	Sn
	Housings	PA, glow wire resistant, GWT 750 °C acc. to IEC 60335-1
	Colour of housing	natural

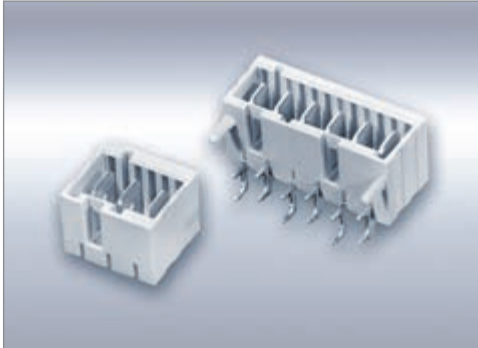

DESCRIPTION OF SYSTEM

- Connector system allowing individual, free contact combinations in accordance with the RAST 5-standard specification for domestic appliances
- SMT version for vertical PC board assembly
- Versions for vertical or horizontal PC board assembly
- For dual-in-line or in-line hole patterns
- Individual polarizing and positioning possible
- Clear grouping of connecting positions using movable inserts or empty spaces
- Neutral and/or grounded bridging contacts
- Polarizing pegs optional
- Advancing tab contacts as grounded conductor optional

Mating connectors

- Suitable for RAST 5 indirect connectors in screw, crimp, or IDC technology
- 8105B / 8105FU (screw type)
- EH 688 / EH 699 (crimp type)
- ECO-DOMO NF (IDC type)

Variants

- ECO-FLEX M Tab connector
- ECO-FLEX ML Tab connector with bridging contacts
- ECO-FLEX BL Socket connector with bridging contacts
- ECO-FLEX MBL Connectors in tab/socket combinations with bridging contacts
- ECO-FLEX SMT Tab connector SMT

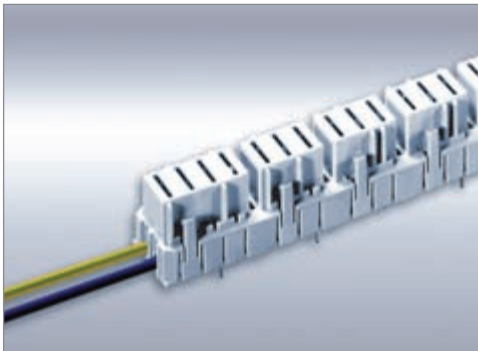

TECHNICAL DATA

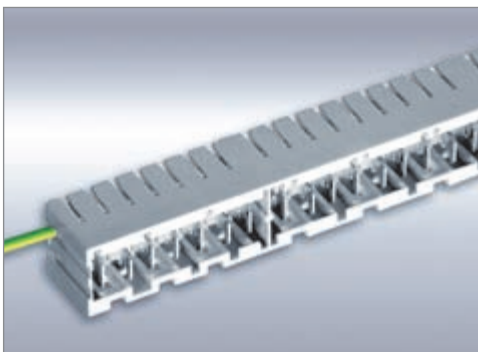

Mechanical	Pitch		5 mm
	Positions		
	- ECO-FLEX M	without inserts with inserts	2 - 12 2 - 20
	- ECO-FLEX ML, BL, MBL;	with inserts or empty spaces	2 - 30*
	Pitch		7.5 mm, 10 mm
Electrical	Termination		soldering
	Temperature range		40 °C ... +120 °C
	Rated current		- Tab contacts 16 A - Socket contacts 10 A - Bridging contacts over IDC 10 A
	Rated voltage		250 V
Materials	Approved		DIN EN 61984 (IEC 61984) UL/ULC E96569 (only series MS 941x)
	Housings		PA, glow wire resistant, GWT 750 °C acc. to IEC 60335-1
	Colour	housing Tab connector SMT	natural black
	Contacts Tabs		6.3 x 0.8 mm
	Contact materials		CuZn / CuSn
	Contact surface		Sn

* depending on number of inserts or empty spaces, higher pole versions on request



DESCRIPTION OF SYSTEM

- Tab connector for IDC termination as flying lead coupling or for panel mounting application
- Different coding variants on request
- Cable exit 90°, 270°
- Label optional
- Mating counterpart e. g. Wiecon 8213 B

TECHNICAL DATA

Mechanical	Positions	2 - 13
	Pitch	5.08 mm
	Termination	IDC
	Wire size	0.35 - 0.5 mm ²
	Temperature range	-40 °C ... +110 °C
Electrical	Rated current	max. 6 A
	Rated voltage	250 V
	Dielectrical strength	≥ 2.5 kV
	Insulation resistance	> 10 ⁹ Ω
	Contact resistance	< 10 mΩ
	Air gap	≥ 4 mm
	Creeping distances	≥ 2.5 mm
Materials	Tracking resistance	CTI ≥ 250
	Housing	PA, glow wire resistant, GWT 750 °C acc. to IEC 60335-1
	Colour of housing	natural
	Associated contacts	RSB 8199
	Contact	CuSn
Contact finishing	Sn	

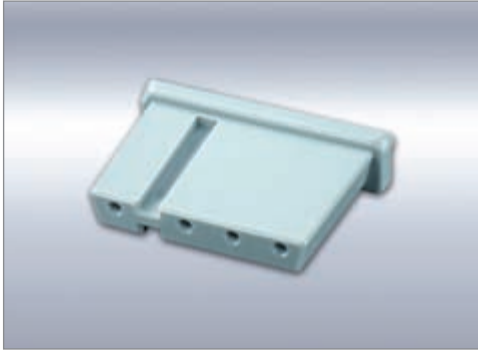

TECHNICAL DATA

Mechanical	Pitch	5.08 / 7.62 mm
	Positions	1-8 / 11
	Termination	crimp
	Temperature range	-40 °C...+100 °C, PBT: +125 °C
	Wire size crimp contact	0.22-1 mm ²
Electrical	Max. current load per contact	4 A
	Rated current	3 A
	Rated voltage	250 V
	Insulation resistance	> 10 ⁹ Ω
	Contact resistance	< 10 m Ω
Materials	Housings	PC, 2-way: PBT
	Crimp contact	RFB 7851 CuSn tin plated

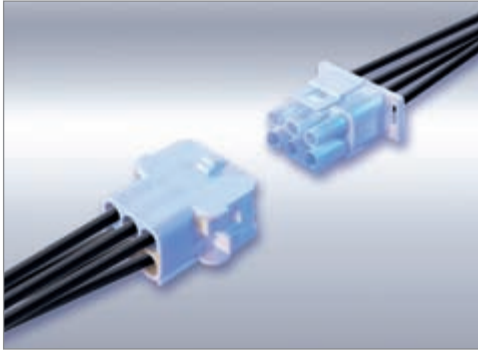

DESCRIPTION OF SYSTEM

- Universal connector system for white goods, industrial electronics and commercial building equipment appliances.
- Application as flying lead assemblies, panel mounting and for PCB connections.
- 2 to 15 positions with crimp contacts and locking feature outside
- Suitable for power connections up to 16 A
- Headers pre-loaded for PCB assembly
- Cable exit 180°
- Coding via contact types
- Clear positioning

TECHNICAL DATA

Mechanical	Pitch	6.35 mm	
	Positions	In-line	2 - 5
		Multi-row	6 - 15
	Termination	Connector / Counter Part	Crimp
		Headers	Solder
	Wire size	0.34 - 0.82 mm ² / AWG 22-18	
		0.75 - 2.03 mm ² / AWG 18-14	
	Locking feature	yes	
	Degree of pollution	2	
	Temperature range	-40 °C ... +110 / +120 °C *	
Electrical	Rated current	max. 16 A	
	Rated voltage	400 V	
	Dielectric strength	2.21 kV	
	Insulation resistance	10 ⁹ Ω	
	Contact resistance	< 10 m Ω	
	Air gap and creeping distances	≥ 4 mm	
	Creeping strength	CTI 600 / ≥ 300 *	
	Surge category	II	
	Insulation group	I / III a *	
	Approved by	UL E306640 and UL/ULC E96569 VDE tested	
Materials	Contact	CuZn, CuSn	
	Contact finishing	Sn	
	Housing	PA	
		PA, glow wire resistant, GWT 750 °C acc. to IEC 60335-1	
	Colour of housing	natural	
	Polarizing	yes	

* Depending on material



DESCRIPTION OF SYSTEM

- 2-pole sensor plug
- Pitch 6.5 mm
- Loadable with flag receptacles 4.8 mm RSB 8186
- Cable exit 90°
- Locking cap
- Different colours

TECHNICAL DATA

Mechanical	Positions	2
	Pitch	6.5 mm
	Termination	Crimp
	Wire size	0.5 - 1.5 mm ² (AWG 20-16)
	Insulation Ø max.	2.8 mm
	Stripping length	4.5 ± 0.5 mm
	Locking feature	Locking cap
	Temperature range	-40 °C ... +110 °C
Mechanical	Rated current	16 A
	Rated voltage	250 V
	Overvoltage category	III
	Test voltage	1.39 kV / 60 s
	Dielectric strength at housing material	5 kV
	Insulation group	III a
	Degree of pollution	3
	Creeping strength	CTI ≥ 325
	Air gap	≥ 1.5 mm
	Creeping distances	≥ 2.5 mm
Materials	Insulation resistance	> 10 ⁹ Ω
	Contact resistance	< 10 m Ω
	Contact material	CuZn
	Contact finishing	Sn
	Housing	PA, glow wire resistant, GWT 750 °C acc. to IEC 60335-1
	Colour of housing	Different colours



DESCRIPTION OF SYSTEM

This connector range, which consists of housings EH 700/4-2 HT and receptacle RSB 8180.1158, is designed to interconnect with tabs 6.3 x 0.8 mm to DIN spec. 46244. The housings have a connector spacing of 8 mm and are ideally suitable to mate with interconnections of electric kitchen hobs. Temperature range max. 270° C.

TECHNICAL DATA

Mechanical	Pitch	8 mm
	Positions	1- 4, up to 6-way on request
	Termination	Crimp
	Wire size	0.5 – 1.5 mm ²
	Insulation Ø max.	3.3 mm
	Coding	yes
	Positioning	yes
	Locking	possible
	Temperature range	-40 °C ... + 270 °C
Mechanical	Rated current	16 A at Tu 240 °C 15 A at Tu 250 °C
	Rated voltage	400 V
	Contact resistance	< 5 m Ω
	Creeping strength	CTI > 175
	Approved by	VDE DIN EN 61984 (IEC61984), ÜG130926 UL 1977 / ULC CAN/CSA C22.2, File E96569
	Materials	Contacts
Contact material		Ni
Housing		PPS-V0, glow wire resistant, GWT 750 °C acc. to IEC 60335
Colour of housing		black



DESCRIPTION OF SYSTEM

- 1 to 4 poles circular connector
- Round contacts for crimp termination
- Sealed according to IP44
- Two-sided external locking latches
- Possibility of coding
- Single or hose cable
- Cable exit 180°
- Clamping possibility for lateral plate cut out
- Housing rip

TECHNICAL DATA

Mechanical	Poles	1 - 4
	Termination	Crimp
	Applicable terminals	
	Socket	RBB 8210
	Pin	RTB 8211
	Split pin, low insertion force	RTB 8212
	Wire size	0.35 - 2.03 mm ²
	Temperature range	-40 °C ... + 120 °C
	Panel thickness	0.8 mm
Elektrical	Rated current	16 A
	Rated voltage	250 V
	Dielectrically strength	> 2.21 kV
	Insulation resistance	> 10 ⁹ Ω
	Contact resistance	< 10 m Ω
	Creeping distance	≥ 2.2 mm
	Creeping strength	CTI ≥ 400
Materials	Housing	PA, glow wire resistant, GWT 750 °C acc. to IEC 60335-1
	Colour of housing	natural
	Contact material	CuZn or CuSn
	Contact finishing	Sn



VERSIONS

- vertical
- horizontal
- single row

TECHNICAL DATA

Mechanical	Positions	up to 40
	Termination	soldering
	Temperature range	-40 °C...+100 °C
Electrical	Max. current load per contact	*
	Rated current	*
	Rated voltage	*
	Insulation resistance	*
	Contact resistance	*
Materials	Contact	CuZn
	Contact finishing	Sn
	Housings	PBT
		PC, glow wire resistant, GWT 750 °C acc. to IEC 60335-1

* Electrical data are dependent on the application.
Information is available on request.



VERSIONS

Single or multi-way housings for receptacles and tabs, available in following versions

- Glow wire resistant, GWT 750 °C acc. to IEC 60335-1
- Flammability class UL 94 V2 or V0
- Natural or in different colours



STOCKO products are fully tested at our laboratories. VDE, UL / ULC and other approvals for the main STOCKO items are regularly updated.

Technical data sheets are available on request.



Receptacles for tab width 6.3 mm, in versions self locking, permanently engaged, with low insertion force, as timer contact, inserted into housing, suitable for RAST 5 connector housings

- Material: brass, phosphor bronze or steel, other materials on request
- Finishing: natural, tin plated or nickel plated
- Wire size: 0.2 - 6 mm² / AWG 24 - 10
- Tab thickness: 0.8 mm in accordance with DIN or IEC specifications
- Temperature range: - 40 °C to +300 °C



Receptacles for tab width 4.8 mm, in versions self-locking, permanently engaged, with low insertion force, inserted into housing

- Material: brass, phosphor bronze or steel, other materials on request
- Finishing: natural, tin plated or nickel plated
- Wire size: 0.14 - 2.5 mm² / AWG 26 - 14
- Tab thickness: 0.5 - 0.8 mm in accordance with DIN or IEC specifications
- Temperature range: - 40 °C to +300 °C



Receptacles for tab width 2.8 mm, in versions permanently engaged, with low insertion force, as timer contact, inserted into housing 3,5

- Material: brass, phosphor bronze or steel, other materials on request
- Finishing: natural, tin plated or nickel plated
- Wire size: 0.14 - 1.5 mm² / AWG 26 - 16
- Tab thickness: 0.5 - 0.8 mm in accordance with DIN or IEC specifications
- Temperature range: - 40 °C to +300 °C

STOCKO products are fully tested at our laboratories. VDE, UL / ULC and other approvals for the main STOCKO items are regularly updated.

Technical data sheets are available on request.

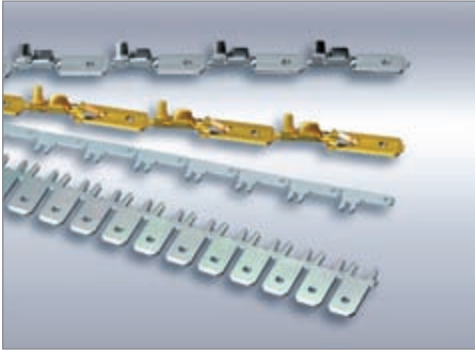

Tabs 2.8 / 4.8 or 6.3 mm wide for STOCKO receptacles

- For crimping
- For PC Board assembly
- Weld tabs

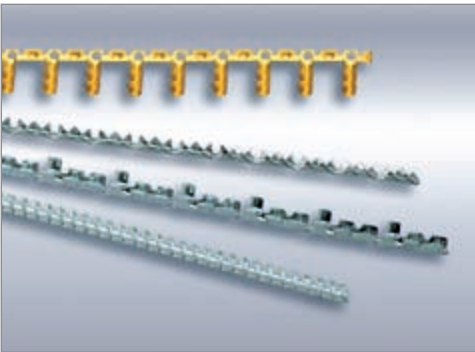

End splices with or without insulation crimp

- For longitudinal or transverse transport
- For stranded or enamel wires
- Wire size: 0.2 - 16 mm² / AWG 24 - 6



Open barrel terminals in ring or c-type version, with or without insulation crimp

- Drill hole diameter: 2.3 - 10 mm
- Wire size: 0.25 - 20 mm² / AWG 22 - 4

Complementary to our product range "Crimp Contacts", STOCKO offers

- Circular sockets
- Circular pins
- PC board contacts
- Miscellaneous special types

STOCKO products are fully tested at our laboratories. VDE, UL / ULC and other approvals for the main STOCKO items are regularly updated.

Technical data sheets are available on request



SPARK PLUG CONNECTORS



SPARK PLUG CONNECTORS



IGNITION LOCK



SCRUBBER BRACKET



NCC PLUG-IN

Bulb holder HiperVision New Cap Concept i. a. for turn indicator or daytime running light

- crimp acc. to VW 60330
- unsealed
- plug-in-Interface
- various hand grips and covers are available



NCC BAJONET

Bulb holder HiperVision New Cap Concept i. a. for turn indicator or fog lamp

- connector socket
- sealed
- bayonet-Interface



H7

Bulb holder for headlight H7
Different contours and grips



BL

Bulb holder for turn indicator and parklight
Customized parts on request

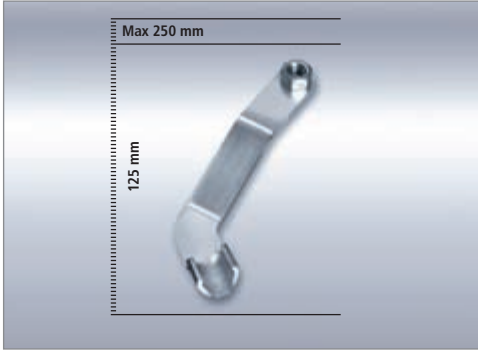

STAMPING PARTS

Precision in big dimension

We have transferred our well-known and usual high precision in the fine blanking range also to big stamping parts. By request, we develop, validate and produce stamping/bending parts with smallest shape and position tolerances, e.g. with regard to solderless terminals and current bridges, in order to meet at any time the increasing precision and quality requirements in the automotive sector.

Features

- Press capacity up to 160 tons
- Sheet thicknesses up to 5 mm
- Band widths up to 300 mm
- Part size up to 120 x 250 mm
- Copper metals, aluminium and steels

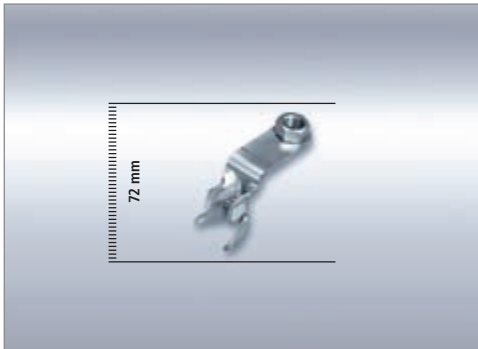
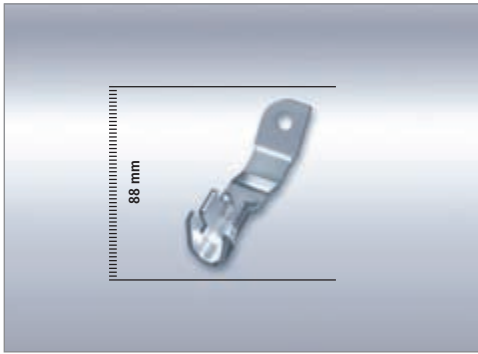

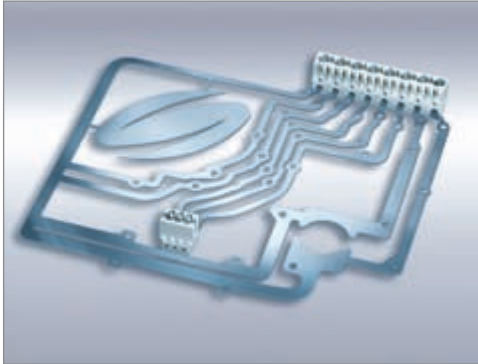

CUSTOMER-SPECIFIC CLINCH FRAMES

- Direct-Connector as an option
- With or without overmoulding
- Contour-forming, also 3D
- Part size up to 120 x 250 mm
- Full-, selective-, or special-finishing
- Various metals and plastics, standard to high temperature

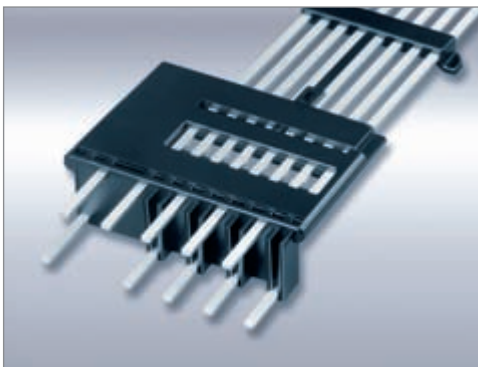
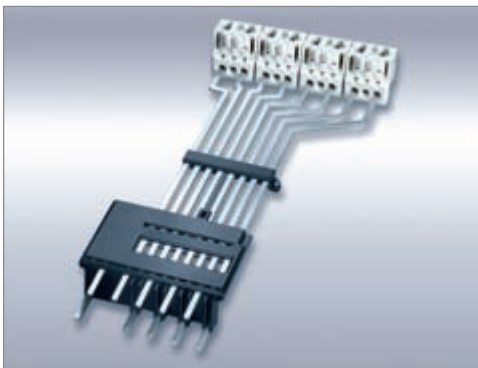
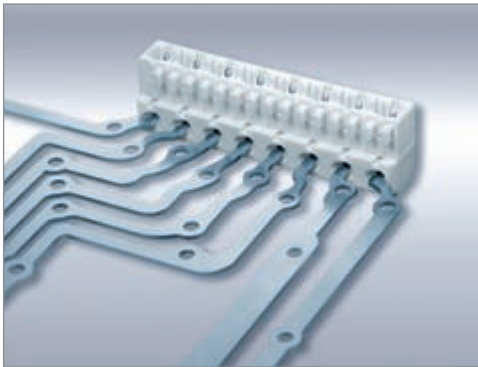

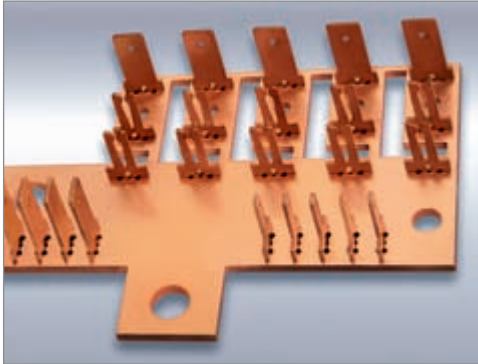

BUSBAR

- Sheet thickness up to 5 mm
- Part size up to 120 x 250 mm
- With or without overmoulding
- Usage:
 - Fuse Box
 - Power distribution
 - Customer specific applications
- Combinable with fuse- and relay-contacts
- Specific materials and surfaces

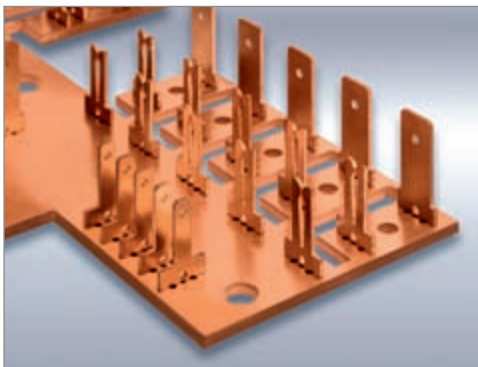
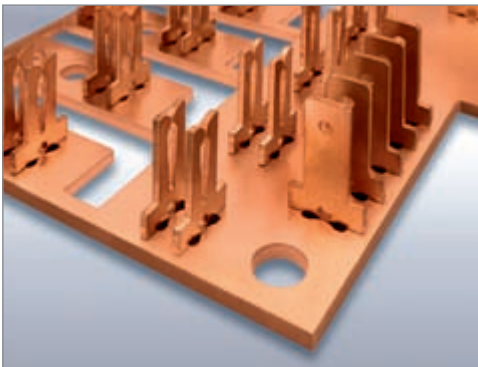



RING TERMINALS WITH ASSEMBLED NUT



LOUDSPEAKER MODULE

Centre disc and contact unit for miniature loudspeakers 13 mm dia.

Application
Mobile telephones



CHARGE CONTACTS FOR BATTERY SHAVERS



- Solderless terminals with and without insulation
- Pin terminals
- Parallel splices
- Butt splices
- Tabs
- Terminating technology:
Cable stripper, hand tools, electrical and hydraulic crimping tools





The quality and reliability of an electrical connection depend largely on the terminating technology. Consequently, STOCKO offers an economical and efficient terminating technique for every product. Whatever the particular requirements and production quantities are, we offer state-of-the-art tools and machinery. From a simple hand tool to semi-automated machines and to fully automated machines of modular construction incorporating "Just-in-Time" functions, Computer controlled machine operation, automated quality control, modem connection for remote diagnostics, and the option to program sequences in cableform output. With the object in mind improving our customers' productivity through optimum production rationalization. A qualified STOCKO team of service engineers is always at your disposal for advice and practical assistance. In an emergency, they attend to prompt machine maintenance and carry out preventative servicing tasks.



- 1 Service hand tool for IDC connector systems
- 2 STOCKOMAT ECO-DOMO professional line
Semi-automated terminating machine for connector ECO-DOMO according to RAST 5 specification
- 3 STOCKOMAT CRIMP professional line
Semi-automatic terminating machine for crimp contacts in bandolier form
- 4 ECO-MASTER
Fully automated terminating machine for connector series ECO-TRONIC, ECO-TRONIC pro and crimp contacts.

CONTACT ADDRESSES

Germany

Head Office
STOCKO Contact GmbH & Co. KG
Simonshöfchen 31
42327 Wuppertal
Phone: +49 202 9733 - 2
Fax: +49 202 9733 - 411
E-Mail: info@stocko-contact.com

(P) STOCKO Contact GmbH & Co. KG
Olefallstr. 26
53940 Hellenthal
Phone: +49 2482 84 - 0
Fax: +49 2482 84 - 240
E-Mail: hellenthal@stocko-contact.com
E-Mail: service-idc@stocko-contact.com

(D) Lorenzgroup Electronic
Distribution und Vertriebsgesellschaft mbH
Schieferstein 6
65439 Flörsheim
Phone: +49 6145 9599-0
Fax: +49 6145 9599-40
E-Mail: info@lorenzgroup.com

(D) HZ GmbH
Technische Kunststoffe & Elektrische
Verbindungstechnik
Johannes-Giesser-Straße 11
71364 Winnenden-Hertmannsweiler
Phone: +49 7195 59069 - 22
Fax: +49 7195 59069 - 29
E-Mail: mail@hz-gmbh.com

(R) Hoppe & Co. Electronic
Inhaber Hans Zeltner e.K.
Thomas-Mann-Straße 50
90471 Nürnberg
Phone: +49 911 327175
Fax: +49 911 327141
E-Mail: info@hoppe-electronic.de

(D) zeb elektroTECHNIK GmbH
Thomas-Mann-Straße 50
90471 Nürnberg
Phone: +49 911 323957-0
Fax: +49 911 327141
E-Mail: info@zeb-gmbh.de

(D) ETB Electronic Team
Beratungs- und Vertriebs GmbH
Wundramweg 1
31303 Burgdorf
Phone: +49 5136 97229-0
Fax: +49 5136 972 9-39
E-Mail: info@etb-electronic.de

Australia

(D) Braemac Pty Ltd
1/59-61 Burrows Road, Alexandria
Sydney, NSW 2015 Australia
Phone: +61 2 95506600
Fax: +61 2 95506377
E-Mail: info@braemac.com.au

Austria

(D) CODICO GmbH
Zwingenstraße 6-8
A-2380 Perchtoldsdorf
Phone: +43 01 86305-0
Fax: +43 01 86305-5000
E-Mail: office@codico.com

Belgium, Luxembourg

(R) ATEM N.V./S.A.
Bedrijvenpark De Veert 4
B-2830 Willebroek
Phone: +32 03 8661800
Fax: +32 03 8661828
E-Mail: info@atem.be

Brazil, South America

(SO) STOCKO CONTACT Brasil Ltda.
Av. Paulista, 1439 - 1º andar Cj12
01311-200 São Paulo / SP / Brasil
Phone: +55 11 4890 2223
Mobile: +55 11 94251 2450
E-Mail: brazil@stocko-contact.com

Canada

(R) WIELAND Electric Inc.
2889 Brighton Rd.
Oakville, ON L6H 6C9
Phone: (905) 829-8414 or 1-800-Wieland
Fax: (905) 829-8413
E-Mail: technical.support@wieland.electric.com

China

(R) STOCKO Contact GmbH & Co. KG
c/o Wieland Electric
Trading (Shanghai) Co. Ltd.
7F, East Huaihai Int'l Mansion,
No 49 Huaihai Road (E),
Huang Pu District, Shanghai
200010, PRC
Phone: +86 21 63555772-126
63555772-127
Fax: +86 21 6355 0090
Mobile: +86 136 36435222
E-Mail: china@stocko-contact.com

(SO) STOCKO Contact GmbH & Co. KG
#3-601, No.42 Dongshan 4th Road,
Qingdao 266100, P.R.China
Mobile: +86 139 69760609
Fax: +86 532 / 66870622
E-Mail: china@stocko-contact.com

(SO) STOCKO Contact GmbH & Co. KG
No 147-149, Changping Avenue,
Lian Guan Plaza, Room 1520,
Guangdong Province, Dongguan City,
Changping Town 523560,
P.R.China
Mobile: +86 137 1278 7427
E-Mail: china@stocko-contact.com

(SO) STOCKO Contact GmbH & Co. KG
Unit 08-1-302, No.184 Taishan Road
New district Changzhou 213022,
P.R.China
Mobil: +86 136 85216240
E-Mail: china@stocko-contact.com

(D) WG Industrial Control Equipment
Suit. 22, No. 328, Hengyong RD
Jiading District
201806 Shanghai, P.R.China
Phone: +86 21 34533671
Fax: +86 21 34311361
E-Mail: sales@wg-ind.com

Croatia, Slovakia, Slovenia, Czech Rep.

(via Codico Partner)
(D) CODICO GmbH
Zwingenstraße 6-8
A-2380 Perchtoldsdorf
Phone: +43 01 86305-0
Fax: +43 01 86305-5000
E-Mail: office@codico.com

Denmark

(R) MATECH SYSTEMS A/S
(D) Ankelbovej 6
7190 Billund
Denmark
Phone: +45 75 338949
Fax: +45 75 338946
E-Mail: info@matechsystems.dk

Estonia, Latvia, Lithuania

(R) Adcontact/Gammeter
Paldiski mnt 31
EE - 76606 Keila, Harjumaa
Phone: +372 671 2251
Fax: +372 671 2253
Mobile: +372 50 89343
E-Mail: info@gammeter.ee

Finland

(R) Adcontact AB Filial I Finland
GAMMETER
Vehnämlyllykatu 6
FIN-33560 Tammerfors
Finland
Phone: +358 3 3802211
Fax: +358 3 3802244
E-Mail: info@gammeter.fi

France

(S) STOCKO CONTACT Eurl
7, Route d'Eichhoffen
CS 40017 Andlau
67145 - BARR Cedex
Phone: +33 388 585858
Fax: +33 388 585888
E-Mail: andlau@stocko-contact.com

(R) M. Roland DOTIGNY
4 Rue Rougette
60240 Liancourt St Pierre
Phone: +33 3 44479168
Fax: +33 3 44479168
E-Mail: roland.dotigny@stocko-contact.com
(Parisienne, Ouest, Normandie, Nord)

(R) CONNECT-SYSTEMES
(D) 31, Impasse de la Balme
69800 Saint-Priest
Phone: +33 4 78901315
Fax: +33 4 78906332
E-Mail: commercial@connect-systemes.fr
(Rhône-Alpes, Sud, Centre, Est)

Greece

(R) S. SAKELLIOU & CO O.E.
Manufacturer's Agents
15B Konstantinidou str.
K. Patissia 104 45 - Athens
Phone: +30 2 108322611
Fax: +30 2 108325444
E-Mail: info@sasta.grr

Great Britain

(D) Cabletrix Ltd.
9/10 James Watt Close
Drayton Field Industrial Estate
Daventry, Northants NN11 8QU, UK
Phone: +44 1327 876769
Fax: +44 1327 300130
E-Mail: sales@cabletrix.co.uk

(D) J-Tronics Ltd
1 Granger Avenue
Acomb
York, YO26 5LF, UK
Phone: +44 1904 795690
Fax: +44 1904 790887
E-Mail: julie@j-tronics.co.uk
If you need a design partner
for harnesses contact:
gareth@j-tronics.co.uk

(D) New Force Ltd
Fair Crest
Conghurst Lane
Hawkhurst
Cranbrook
Kent
TN18 5DZ
TPhone: 01580 752014
E-Mail: sales@new-force.co.uk

Hungary

(R) CZINEGE és FIAI Kft.
(D) Pesti ucta 36,
H-5100 - Jászberény
Phone: +36 057 500190
Fax: +36 057 500191
E-Mail: czinege@czinege.hu

India, Sri Lanka, UAE

(D) AURO CONTROLS PRIVATE LIMITED
Florina Apartment, 6th Floor,
Survey No. 2/1/7, Erandwane,
Pune 411004 INDIA
Phone: +912025465915
E-Mail: sales@aurocontrols.com

Indonesia

(D) PT. Esecodharma Permai
Green Sedayu Biz Park Daan Mogot
JL. Raya Daan Mogot KM.18
Blok DM-2 No.18, Jakarta Barat, 11840
Phone: +62 21 5696 8822
Fax: +62 21 5696 8811
E-Mail: eseco-mkt@eseco.co.id

Ireland, Republik of

(D) Cabletrix Ltd.
9/10 James Watt Close
Drayton Field Industrial Estate
Daventry, Northants NN11 8QU, UK
Phone: +44 1327 876769
Fax: +44 1327 300130
E-Mail: sales@cabletrix.co.uk

Italy

(R) KLEMI Contact Srl
(D) via Monferrato, 43
20098 San Giuliano Milanese (MI)
Italy
Phone: 39-02-5560.6101
Fax: +39-02-5560.7134
E-Mail: klemi@klemi-contact.com

- (D)** Distribution
- (P)** Plant
- (R)** Representation
- (S)** Subsidiary
- (SO)** Sales Office

Japan

(SO) STOCKO CONTACT GmbH & Co.KG
c/o Wieland Electric Co., Ltd.
Nisso No. 16 Bldg. 3-8-8
Shin-Yokohama Kohoku-ku Yokohama
222-0033 Japan
Phone: +81-45-473-5085
Fax: +81-45-470-5408
E-Mail: japan@stocko-contact.com

Korea

(D) Sam Tra International
Hoseo Venture Tower 609 Ho
319 Gasan-dong
Geumcheon-gu, Seoul 153-711
Korea
Phone: +82 2 26275625
Fax: +82 2 26275629
E-Mail: sales@samtra.co.kr

(SO) Stocko Contact GmbH & Co. KG
Korea Office
Level 41, Gangnam Finance Center
152 Teheran-ro, Gangnam-gu,
Seoul 06236
Korea
Phone: +82 2 2008 4580
Mobile: +82 10 5809 5970
Fax: +82 2 2008 4555
E-Mail: korea@stocko-contact.com

Malaysia

(D) C.T.M. Industries Sdn. Bhd
(Penang Office)
14 & 16 Lorong Nagasari 4,
Kawasan Perusahaan Prai,
13600 Prai, Malaysia.
Phone: +60 4 397 9202
Fax: +60 4 397 9155
E-Mail: pg-ctm@ese-group.com

(D) C.T.M. Industries Sdn. Bhd
(Kuala Lumpur Office)
Suite 719, Blk B2,
Leisure Commerce Square,
No. 9, Jalan PJS 8/9,
46150 Petaling Jaya,
Selangor Darul Ehsan, Malaysia.
Phone: +60 3 7875 3212
Fax: +60 3 7875 3302
Email: pg-ctm@ese-group.com

Mexico

(SO) STOCKO CONTACT GmbH & Co. KG
Sales Office Texas
El Paso
Phone: +1 915 309 5363
E-Mail: Mexico@stocko-contact.com

Netherlands

(D) AVT Industrial Components
Freddy van Riemsdijkweg 7
5657 EE Eindhoven
Phone: +31 40 2088088
Fax: +31-40-2088099
E-Mail: sales@avtic.com

Norway

(R) Adcontact/Gammeter
(D) P.O. Box 246 Skøyen
N-0213 Oslo
Phone: +47 22417700
Fax: +47 22417701
E-Mail: info@adcontact.se

Philippines

(D) C.T.P. Industries, Inc
Unit # 1001 Primeland Tower,
2218 Market Street,
Madrigal Business Park, Ayala Alabang,
Muntinlupa City, Philippines 1771
Phone: +63 2 245 0632 / 245 0639
Fax: +63 2 836 7968
E-Mail: admin@ctp.com.ph

Poland

(D) EVOLTEC Tomasz Pawlowski
ul. Bekasów 63/65
02-803 Warszawa
TPhone:+48 22 550 27 40-44
Tel.: +48 22 550 27 47
Fax: +48 22 550 27 45
E-Mail: info@evoltec.pl

Portugal

(SO) STOCKO CONTACT GmbH & Co. KG
Sales Office Spain / Portugal
F. Rius i Taulet, 19-3°
E-08850 Gavà (Barcelona)
Phone: +34 936 627188
Fax: +34 936 627188
Mobile: +34 676 490974
E-Mail: spain@stocko-contact.com

Russia

(D) CE Engineering
Krasnokazarmennaya 3 build 5
Moscow 111250
Russia
Tel.: +7 495 2563541
Fax: +7 495 9671561
E-Mail: info@faston.ru

(D) ELCO Group LLC
13A, Building 4, Structure 4
Varshavskoye Shosse
Moscow 115230
Phone: +7 495 9818516
Fax: +7 495 7750255
E-Mail: info@elcogroup.ru

Belarus

(D) FEK Company
Pushkina 29-B
220016 MINSK
Belarus
Phone: +375 17 2102189
Fax: +375 17 2102189
E-Mail: info@fek.by

Singapore

(SO) STOCKO Contact GmbH & Co. KG
Liaison Office Singapur
Blk 5, Rivervale Crescent
08-05 Singapore 545084
Mobile: +65 91 832131
E-Mail: singapore@stocko-contact.com

(D) C.T.S. Industries Pte Ltd
47 Kaki Bukit Place,
Eunos Techpark,
Singapore 416225
Phone: +65 6276 3328
Fax: +65 6276 3336
E-Mail: sales_cts@ese.com.sg

Sweden

(R) Adcontact/Gammeter
(D) Ursviksv. 127B
P.O. Box 7044
S-17407 Sundbyberg
Phone: +46 8 4453600
Fax: +46 8 4453610
E-Mail: info@adcontact.se

Switzerland

(R) AWAG Elektrotechnik AG
(D) Sandbühlstrasse 2
CH-8604 Volketswil
Phone: +41 044 9081919
Fax: +41 044 9081999
E-Mail: info@awag.ch

Spain

(SO) STOCKO CONTACT GmbH & Co. KG
Sales Office Spain / Portugal
F. Rius i Taulet, 19-3°
E-08850 Gavà (Barcelona)
Phone: +34 936 627188
Fax: +34 936 627188
Mobile: +34 676 490974
E-Mail: spain@stocko-contact.com

(D) TC Componentes, S.L.
Cami de Can Calders,6 12-G
E-08173 Sant Cugat del Vallès
Barcelona
Phone: +34 93 590 28 30
Fax: +34 93 590 02 67
E-Mail: info@tc-componentes.es

South Africa

(R) APT Advanced Product Technology (PTY) LTD.
Corner Remblok and Langwa street
Strijdom Park
Randburg
South Africa 1 7926010
Fax: +27 11 7929879
E-Mail: craig@apta.co.za

Taiwan

(D) Cian Shin Industrial Co.,LTD
4F., No.33, Ren'ai St. Tamsui Dist.,
New Taipei City 25168 Taiwan (R.O.C.)
Phone: +886 2 26230681
Fax: +886 2 26231920
E-Mail: sales@cianshin.com.tw

Thailand

(D) ST Global Industries Co., Ltd.
36 Moo 4, Tambon Pimpha
Amphur Bangpakong
Chachoengsao, 24130
Thailand
Phone: +66 38 595983
Fax: +66 38 595363
E-Mail: stglobal@st-global.co.th

Turkey

(SO) STOCKO CONTACT GmbH & Co. KG
Istanbul Liaison Office
Atakoy 11. Kisim, Cigdem D Blok, D:33
34158 Istanbul / TURKIYE
Phone: +90 212 6618710
Fax: +90 212 6618720
E-Mail: info@stockotr.com

USA

(SO) STOCKO CONTACT GmbH & Co. KG
Sales Office Michigan
Detroit
Cell: +1 248 5719596
E-Mail: usa@stocko-contact.com

(SO) STOCKO CONTACT GmbH & Co. KG
Sales Office Illinois
Chicago
913 N Neva Ave
Addison, IL 60101
Cell: +1 630 5185089
E-Mail: usa@stocko-contact.com

(SO) STOCKO CONTACT GmbH & Co. KG
Sales Office Texas
El Paso
Cell: +1 915 309 5363
E-Mail: usa@stocko-contact.com

(SO) STOCKO CONTACT GmbH & Co. KG
Sales Office Kentucky
Morehead
Cell.: +1 606 356 3499
E-Mail: usa@stocko-contact.com

Vietnam

(D) C.T.S. Industries (Indochina) Co., Ltd
(Hanoi Head Office)
165 Thai Ha Street, Lang Ha Ward,
Song Hong Land Office Building,
Unit 2, 5th Floor,
Dong Da District, Hanoi, Vietnam
Phone: +84 4 3203 2999
Fax: +84 4 3201 2999
E-Mail: sales@ctsindochina.com.vn

(D) C.T.S. Industries (Indochina) Co., Ltd
(Ho Chi Minh Branch Office)
5th Floor, Mekong Tower,
235 - 241 Cong Hoa Street.,
Tan Binh District,
Ho Chi Minh City, Vietnam
Tel: +84 8 3600 0826
Fax: +84 8 6281 6568
E-Mail: sales@ctsindochina.com.vn

STOCKO CONTACT
GmbH & Co. KG

Simonshöfchen 31
D-42327 Wuppertal

Phone +49 202 9733 - 2
Fax +49 202 9733 - 411

E-Mail info@stocko-contact.com
Internet www.stocko-contact.com

A Member of the Wieland Group

